

Anbausätze für Stellungsregler Attachment kits for positioners Kits de montage pour les positionneurs



Diese Technische Information für Anbausätze bietet eine Übersicht über Anbaumöglichkeiten von Foxboro Eckardt Stellungsreglern und Stellungsumformern an gängige Hub- und Schwenkantriebe.

This technical information gives an overview of the attachment possibilities of Foxboro Eckardt Positioners and Positions transmitters on linear and rotative actuators.

Cette information technique donne une vue d'ensemble des possibilités de montage des positionneurs et recopies de position de Foxboro Eckardt sur des servomoteurs linéaires ou rotatifs.

**Standard-Anbausätze
Standard attachment kits
Kits de montage standard**

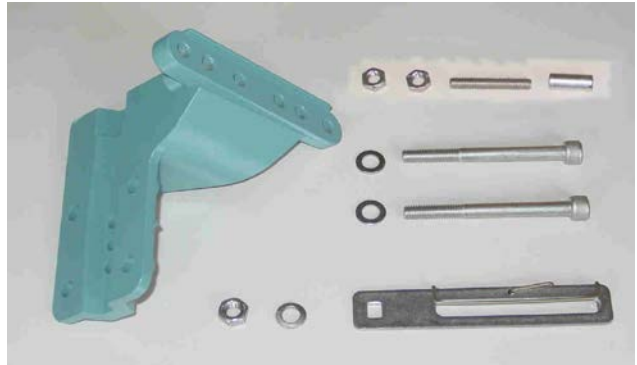

Type / Version	Model Code of attachment kit	SRD991 SR1990	SRD960	SRP981	SR1983	SR1986	SGE985	SM1983	SMP981
----------------	------------------------------	------------------	--------	--------	--------	--------	--------	--------	--------

Hubantriebe / Linear actuators / Servomoteurs linéaires NAMUR

Für Gußlaterne / for casting yoke / pour arcade	EBZG-GN (incl. Standard-Anlenkhebel/ incl. standard couple lever / incl. Levier de raccordement standard a=72mm)								
	EBZG-HN (incl. Standard-Anlenkhebel/ incl. standard couple lever / incl. Levier de raccordement standard a=72mm)								
	EBZG-IN (EBZG-HN mit kurz Winkel / EBZG-HN with small mounting bracket / EBZG-HN avec equerre courte)								
	EBZG-H (incl. Standard-Anlenkhebel/ incl. standard couple lever / incl. Levier de raccordement standard Hub/stroke/course 8-70mm)								
	EBZG-H1 (EBZG-H1 mit kurz Winkel / EBZG-H1 with small mounting bracket / EBZG-H1 avec equerre courte)								
	EBZG-H6 (Edelstahl / Stainless steel / Inox)								

Für Pfeilerlaterne / for pillar yoke / pour arcade à pilier	EBZG-FN (incl. Standard-Anlenkhebel/ incl. standard couple lever / incl. Levier de raccordement standard a=72mm)								
	EBZG-KN (incl. Standard-Anlenkhebel/ incl. standard couple lever / incl. Levier de raccordement standard a=72mm)								
	EBZG-K (incl. Standard-Anlenkhebel/ incl. standard couple lever / incl. Levier de raccordement standard Hub/stroke/course 8-70mm)								
	EBZG-K1 (incl. Standard-Anlenkhebel/ incl. standard couple lever / incl. Levier de raccordement standard Hub/stroke/course 8-70mm)								
	EBZG-K5 (incl. Standard-Anlenkhebel/ incl. standard couple lever / incl. Levier de raccordement standard Hub/stroke/course 8-70mm)								

VDI/VDE 3847 Part 1 for linear actuator

Mounting according the VDI/VDE3847 part1 standard	EBZG-N1								
	EBZG-N4								

Für Hubantriebe / for linear actuators / pour actionneurs linéaires

For arcade without drilling	EBZG-H5								

Zubehör / accessories / accessoires

For some applications for example like large stroke, the above kits can be completed with accessories describe in page 3 and 4.

Für spezielle Anwendungen, z.B. bei längerem Hub, können die oben genannten Teilesätze mit dem Zubehör auf S.3 und S.4 ergänzt werden.

Pour des applications comme par exemple des très grandes courses, les kits ci dessous peuvent être completer par des accessoires décrits page 3 et 4.

Anlenkhebel für SRD991 - SRI990 - SRD960
Feedback lever for SRD991 - SRI990 - SRD960
levier de raccordement pour SRD991 - SRI990 - SRD960

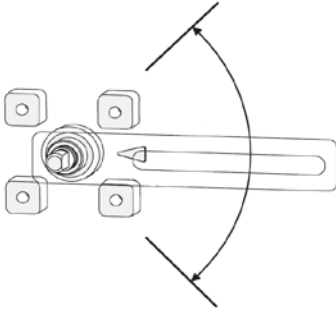

Maximum rotation of Feedback lever for SRD991 - SRI990 - SRD960 is 90°

EBZG-A

Feedback lever for stroke 8 to 70mm

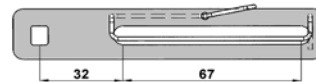

EBZG-B

Feedback lever for stroke 60 to 120mm

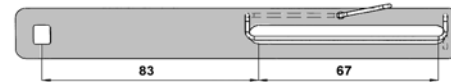

EBZG-A1

Extended feedback lever for stroke 110 to 260mm

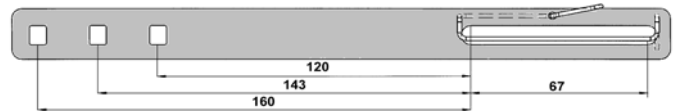

EBZG-A2

Extra short feedback lever for stroke 5 to 15mm

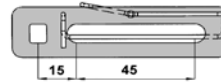

EBZG-A3

Feedback lever fold for stroke 8 to 70mm



EBZG-A4

Short feedback lever for stroke 8 to 35mm

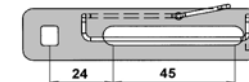

Anlenkhebel für SRP981-SRI983 - SRI986 - SMI983 - SMP981 - SGE985
Feedback lever for SRP981-SRI983 - SRI986 - SMI983 - SMP981 - SGE985
levier de raccordement pour SRP981-SRI983 - SRI986 - SMI983 - SMP981 - SGE985

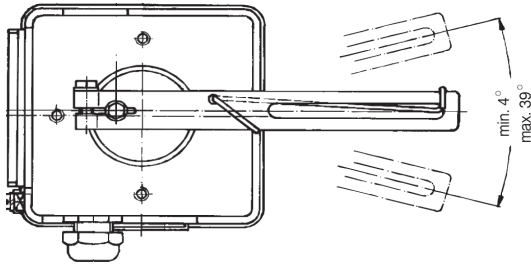

**Maximum rotation of Feedback lever for
 SRP981 - SRI983 - SRI986 - SMI983 -
 SMP981 - SGE985 is 39°**

EBZG-ON
 Feedback lever for stroke up to 50mm

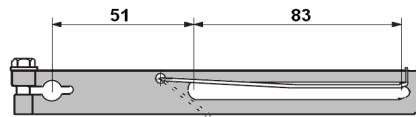

EBZG-AN
 Feedback lever for stroke up to 80mm

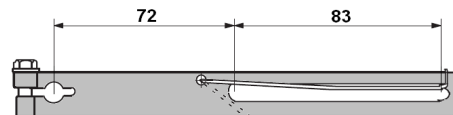

EBZG-AN1
 Feedback lever for stroke 100mm to 150mm

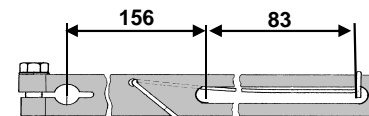

EBZG-AN2
 Feedback lever for stroke 130mm to 170mm

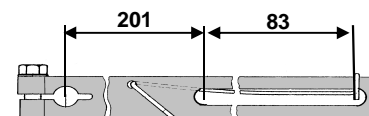

EBZG-AN3
 Feedback lever for stroke 170mm to 210mm

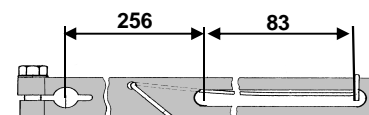

EBZG-AN4
 Feedback lever for stroke 190mm to 230mm

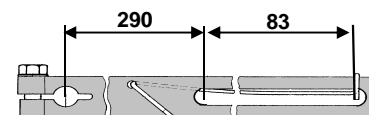

EBZG-AN5
 Feedback lever for stroke 210mm to 250mm

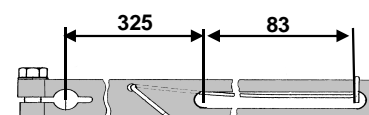

EBZG-BN
 Feedback lever for stroke up to 100mm

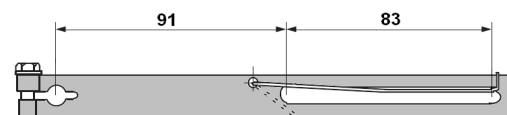

Extended lever for SRP981-SRI983-SRI986 up to 250mm available on request
 Anlenkhebel für SRP981-SRI983-SRI986 mit verlängertem Hubbereich bis 250 mm auf Anfrage
 Leviers pour SRP981-SRI983-SRI986 pour course jusqu'à 250mm disponible sur demande

Anlenkbolzen
Carrier bolt
Doigt d'entraînement

SRXG-A
 Extra short carrier bolt 23

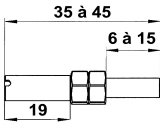
SRXG-B
 Adjustable carrier bolt
 (20mm up to 37mm)

SRXG-C
 Carrier bolt 38mm

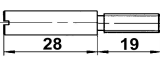

SRXG-D
 Carrier bolt 47mm

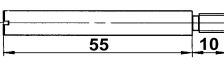
SRXG-E
 Carrier bolt 57mm

SRXG-F
 Carrier bolt 65mm

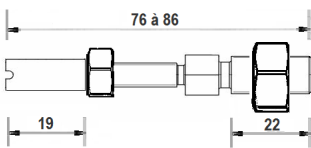
SRXG-I
 Carrier bolt 80mm

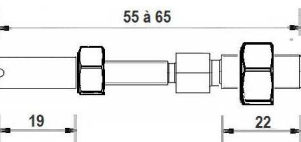

SRXG-J
 Adjustable carrier bolt 3/8" / M6

SRXG-K
 Adjustable carrier bolt 5/16" / M6

SRXG-L
 Extension for carrier bolt

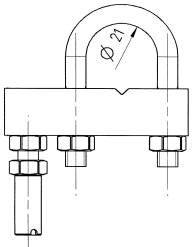

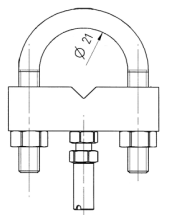
Anlenkbolzen mit Befestigung system
Carrier bolt with fixing system
Doigt d'entraînement avec système de fixation

SRXG-G
 Adjustable carrier bolt (SRXG-B)
 with fixing system for stem diameter up to 21mm

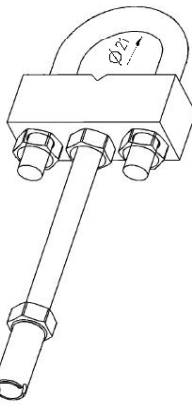
SRXG-G1
 Adjustable carrier bolt (SRXG-B)
 with fixing system for stem diameter up to 21mm

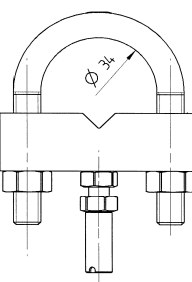
SRXG-G2
 Adjustable carrier bolt (SRXG-B)
 with fixing system for stem diameter up to 21mm
 with extension up to 80 mm

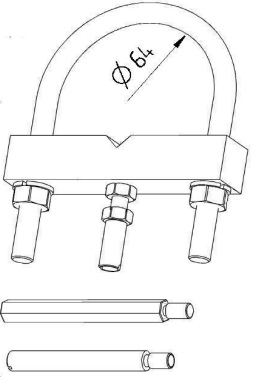
SRXG-H
 Adjustable carrier bolt (SRXG-B)
 with fixing system for stem diameter up to 34mm

SRXG-M
 Adjustable carrier bolt (SRXG-B)
 with fixing system for stem diameter up to 64mm

Standard- und Sonder- Anbausätze, sortiert nach Hersteller / Typ des Antriebes
Standard and specific attachment kits classify by manufacturer / type of actuator
Kits de montage standard et spécifique par constructeurs / type de servomoteur

Type / Version	Model Code of attachment kit	SRD991 SRI990	SRD960	SRF981	SR1983	SR1986	SGE985	SIM983	SMP981
ABB									
Model DSCV-G111/D16R	EBZG-Q2	•	•						
Model DSCV-G111/D28R	EBZG-Q1	•	•						
ADAREG									
	EBZG-H3	•	•						
Micro flow (type NM1 1/2")	EBZG-H4	•	•						
Without drilling the actuator / without existing holes	EBZG-H5	•	•						
AIR TORQUE									
Schwenkantrieb / rotary actuator / servomoteur rotatif VDI/VDE 3845 => page 6 Anbaukonsole / Mounting bracket / console de montage VDI/VDE 3845 => page 14									
AMC & BAILEY									
(1) Cylinder Type SME0608	EBZG-X4	•	•						
(1) Cylinder Old Type	EBZG-X5	•	•						
AMG									
Schwenkantrieb / rotary actuator / servomoteur rotatif VDI/VDE 3845 => page 6 Anbaukonsole / Mounting bracket / console de montage VDI/VDE 3845 => page 14									
AMRI - KSB									
Schwenkantrieb / rotary actuator / servomoteur rotatif VDI/VDE 3845 => page 6									
(1) Old rotary actuator	EBZG-X3 (1)	•	•						
AMSTRONG									
	EBZG-AM			•	•	•			
	EBZG-AM1	•	•						
ARCA									
Baureihe 812	EBZG-GN			•	•		•	•	•
	EBZG-HN					•			
	EBZG-H	•	•						
Direct-mounting	EBZG-P2	•	•						
ARI									
	EBZG-FN			•	•		•	•	•
	EBZG-KN					•			
	EBZG-K	•	•						
Direct-mounting	EBZG-P1	•	•						
AUTOMAX (FLOWERVE)									
Super Nova serie	Schwenkantrieb / rotary actuator / servomoteur rotatif VDI/VDE 3845 => page 6								
BAR									
2									
BETTIS									
Rotary G Series and Rack and pinion RPC series	Schwenkantrieb / rotary actuator / servomoteur rotatif VDI/VDE 3845 => page 6								
BIFFI									
Schwenkantrieb / rotary actuator / servomoteur rotatif VDI/VDE 3845 => page 6									
	EBZG-J	•	•						
Old rotary actuator	EBZG-JN			•	•	•	•	•	•
Bormann & Neupert									
Schwenkantrieb / rotary actuator / servomoteur rotatif VDI/VDE 3845 => page 6									
Bray									
Series 90/91	Schwenkantrieb / rotary actuator / servomoteur rotatif VDI/VDE 3845 => page 6								
Cashco									
Linear actuators type 25, 30, 55, 75, 115 Direct and Reverse	EBZG-GN			•	•		•	•	•
	EBZG-HN					•			
	EBZG-H	•	•						
	EBZG-PN			•	•	•	•	•	•
Rotary spring diaphragm type 48, 148, 148X	EBZG-R	•	•						

(1) One genuine part of AMRI is worked and used for feedback coupling part
 Ein nachgearbeitetes Originalteil von AMRI dient als Kupplung in diesem Anbausatz
 Une pièce d'origine AMRI est ré-usinée pour l'entraînement du positionneur

Standard- und Sonder- Anbausätze, sortiert nach Hersteller / Typ des Antriebes
Standard and specific attachment kits classify by manufacturer / type of actuator
Kits de montage standard et spécifique par constructeurs / type de servomoteur

Type / Version	Model Code of attachment kit	SRD991 SR1990	SRD960	SRP981	SR1983	SR1986	SGE985	SM1983	SMP981
EBRO	Schwenkantrieb / rotary actuator / servomoteur rotatif VDI/VDE 3845 => page 6								
EL-O-MATIC	Schwenkantrieb / rotary actuator / servomoteur rotatif VDI/VDE 3845 => page 6 Anbaukonsole / Mounting bracket / console de montage VDI/VDE 3845 => page 14								
FESTO	Schwenkantrieb / rotary actuator / servomoteur rotatif VDI/VDE 3845 => page 6								
FIP									
Others sizes please contact us	EBZG-TM4	•	•						
FISCHER									
Type 657,type 667 (linear) sizes 30 - 40	EBZG-F1	•	•						
	EBZG-TN (1)			•	•		•	•	•
	EBZG-QN (1)					•			
Type 657,type 667 (linear) sizes 45 - 60	EBZG-F3	•	•						
Type 657,type 667 (linear) sizes 70-100	EBZG-F4	•	•						
Type 3024S (linear)	EBZG-FN			•	•		•	•	•
	EBZG-KN					•			
	EBZG-K	•	•						
Type 1250 (linear)	EBZG-FN			•	•		•	•	•
	EBZG-KN					•			
	EBZG-K	•	•						
(1) Type 1051, 1052 (rotary) size 20	EBZG-F9	•	•						
(1) Type 1051, 1052 and 1061 (rotary) size 33	EBZG-F5	•	•						
(1) Type 1051, 1052 and 1061 (rotary) size 40, size 30	EBZG-F2	•	•						
(1) Type 1051, 1052 and 1061 (rotary) size 60	EBZG-F6	•	•						
Valve/Actuator GX (linear)	EBZG-GN			•	•		•	•	•
	EBZG-HN					•			
	EBZG-H	•	•						
FISCHER - BAUMANN									
9000 sries	EBZG-F7	•	•						
42000 sries	EBZG-F8	•	•						
24000 series (linear)	EBZG-GN			•	•		•	•	•
	EBZG-HN					•			
	EBZG-H + SRXG-K	•	•						
FISCHER - GULDE									
Type P	EBZG-UN			•	•		•	•	•
	EBZG-FN			•	•		•	•	•
(2) Type S	EBZG-KN					•			
	EBZG-K	•	•						

(1) Since this reference covers a wide range of actuators, the user might have to adapt certain attachment kits for some actuators slightly
 Da sich diese Referenz auf eine größere Anzahl von Antrieben bezieht, könnten geringfügige Änderungen bei Anbausätzen einiger Antriebe erforderlich sein
 Comme cette référence couvre une très large gamme de servomoteurs, il se peut que le client pour quelques servomoteurs soit obligé d'adapter légèrement notre kit de montage

(2) For some application mounting square must be worked
 Für manche Anwendungen muss der Anbauwinkel nachgearbeitet werden
 Pour certains servomoteurs, l'équerre de montage doit être usinée (raccourcie).

Standard- und Sonder- Anbausätze, sortiert nach Hersteller / Typ des Antriebes
Standard and specific attachment kits classify by manufacturer / type of actuator
Kits de montage standard et spécifique par constructeurs / type de servomoteur

Type / Version	Model Code of attachment kit	SRD991 SR1990	SRD960	SRP981	SR1983	SR1986	SGE985	SMP983	SMP981
FOXBORO									
P-Series	EBZG-H1	•	•						
GEFA									
Schwenkantrieb / rotary actuator / servomoteur rotatif VDI/VDE 3845 => page 6									
GEMÜ									
Type 514 40D 1375 1 4 2061	EBZG-TM2	•	•						
Type 514 50D 1375 1 2 2061	EBZG-TM3	•	•						
Others sizes please contact us									
GEORG FISCHER (+GF+)									
Diastar (5 sizes: Head Ø =68-96-120-150 or 180mm)	EBZG-TM1	•							
Others sizes please contact us									
HAGAN									
Cylinder	EBZG-X1	•	•	<- righthand mounting					
2 1/2 X5 Thrust type swivel power positioner	EBZG-X2	•	•	<- lefthand mounting					
Others sizes please contact us									
HONEYWELL									
Baureihe 2000 (pillar yoke)	EBZG-FN			•	•		•	•	•
	EBZG-KN					•			
	EBZG-K	•	•						
Air-O-Motor Type 05	EBZG-SA			•	•	•	•	•	•
HYTORK									
Excel, Genesis,	Schwenkantrieb / rotary actuator / servomoteur rotatif VDI/VDE 3845 => page 6								
IAL									
	EBZG-VN			•	•				
	EBZG-WN					•			
INGERSOLL - RAND									
	EBZG-W2	•							
	EBZG-KN					•			
	EBZG-K	•	•						
JAMESBURY									
Quadra Power (old type)	EBZG-J1	•	•						
RP-SR Series (old type)	EBZG-J2	•	•						
KEYSTONE (TYCO)									
Model 79D, 79U, TRP	Schwenkantrieb / rotary actuator / servomoteur rotatif VDI/VDE 3845 => page 6 Anbaukonsole / Mounting bracket / console de montage VDI/VDE 3845 => page 14								
KÄMMER (FLOWERVE)									
(for direct mounting)	EBZG-FN			•	•		•	•	•
	EBZG-KN					•			
	EBZG-E	•	•						
	EBZG-K	•	•						
KINETROL									
Model 05	EBZG-K2	•							
Model 07	EBZG-K3	•							
Model 09	EBZG-K4	•							
Others Model contact us									
KOSO									
Models 110D + 501D + 511D	EBZG-H	•	•						

Standard- und Sonder- Anbausätze, sortiert nach Hersteller / Typ des Antriebes
Standard and specific attachment kits classify by manufacturer / type of actuator
Kits de montage standard et spécifique par constructeurs / type de servomoteur

Type / Version	Model Code of attachment kit	SRD991 SRI990	SRD960	SRP981	SRI983	SRI986	SGE985	SMI983	SMP981
MASONEILAN									
37/38 (linear) sizes 15 / 18	EBZG-TN (1)			•	•		•	•	•
	EBZG-QN (1)					•			
	EBZG-M2	•	•						
37/38 (linear) sizes 9 / 11 / 13	EBZG-TN (1)			•	•		•	•	•
	EBZG-QN (1)					•			
	EBZG-M6	•	•						
87/88 all size (linear)	EBZG-DN (1)					•			
	EBZG-EN (1)			•	•		•	•	•
87/88 with stroke < 80mm	EBZG-M4	•	•						
87/88 with stroke > 80mm	EBZG-M4 + EBZG-B	•	•						
28000 Series VARIPAK	EBZG-LN					•			
	EBZG-MN			•	•		•	•	•
	EBZG-M5	•	•	Not valid for SRI990!					
Paramax		planned	planned						
CAMFLEX I	EBZG-M8 (new design)	•	•						
35000 Series CAMFLEX II	EBZG-RN			•	•	•	•	•	•
	EBZG-M	•	•						
MINITORK I	EBZG-M9	•	•	<- The thread where the carrier bolt is screwed muss be adapted to M6					
37000 Series MINITORK II	EBZG-RN			•	•	•	•	•	•
	EBZG-M	•	•						
47/48 SIGMA F	EBZG-SN			•	•	•	•	•	•
	EBZG-M1	•	•						
71 DOMOTOR size A	EBZG-M7	•	•						
MECAIR									
Serie NOVA	Schwenkantrieb / rotary actuator / servomoteur rotatif VDI/VDE 3845 => page 6								
NAF (FLOWERVE)									
NAF-RC	Schwenkantrieb / rotary actuator / servomoteur rotatif VDI/VDE 3845 => page 6								
NAF-Turnex (direct mounting)	EBZG-N9	•	•						

(1) Since this reference covers a wide range of actuators, the user might have to adapt certain attachment kits for some actuators slightly

Da sich diese Referenz auf eine größere Anzahl von Antrieben bezieht, könnten geringfügige Änderungen bei Anbausätzen einiger Antriebe erforderlich sein

Comme cette référence couvre une très large gamme de servomoteurs, il se peut que le client pour quelques servomoteurs soit obligé d'adapter légèrement notre kit de montage

Standard- und Sonder- Anbausätze, sortiert nach Hersteller / Typ des Antriebes
Standard and specific attachment kits classify by manufacturer / type of actuator
Kits de montage standard et spécifique par constructeurs / type de servomoteur

Type / Version	Model Code of attachment kit	SRD991 SRI990	SRD960	SRP981	SRI983	SRI986	SGE985	SMI983	SMP981
NELES - METSO									
Rotary actuators Type BJ and BC size 8 & 10 Mounting with feedback levers	EBZG-L1	•	•						
Type Ec and EJ	EBZG-L4	•	•						
Rotary actuators Type B1CU C/20 E	EBZG-L5	•	•						
Rotary actuators Type BJ and BC size 8 to 16 Mounting with direct rotary coupling	EBZG-L6	•	•						
Rotary actuators Type BJ and BC size 25 to 50 Mounting with original Neles's rotary coupling	EBZG-L7	•	•						
Rotary actuators BJ and BC6 Mounting with feedback levers	EBZG-L8	•	•						
NORBRO (FLOWSERVE)									
Schwenkantrieb / rotary actuator / servomoteur rotatif VDI/VDE 3845 => page 6 Anbaukonsole / Mounting bracket / console de montage VDI/VDE 3845 => page 14									
NORGREN									
(1) Cylinder Type RA/8100 (250 mm stroke) Others sizes please contact us	EBZG-X7	•	•						
NUOVO PIGNONE (GE Power)									
Same attachment kit than for Masoneilan 37/38									
OMAL									
Schwenkantrieb / rotary actuator / servomoteur rotatif VDI/VDE 3845 => page 6									
ORIGA									
(1) Cylinder Type AZ5063 (300 mm stroke) Others sizes please contact us	EBZG-X6	•	•						
PETRAS									
In association with a special kit from Petras	EBZG-NN			•	•	•	•	•	•
	EBZG-R	•	•						
POLNA									
Linear Type 37/38 size 9,11,13	EBZG-M6	•	•						
Linear Type 37/38 size 15, 18	EBZG-M2	•	•						
Linear Type P1/R1 with stroke < 80mm	EBZG-M4	•	•						
Linear Type P1/R1 with stroke > 80mm	EBZG-M4 + EBZG-B	•	•						
Linear Type P3/R3	EBZG-E	•							
	EBZG-E1		•						
Linear Type P/R	EBZG-K	•	•						
Rotary BR33 Series	EBZG-P3	•	•						

(1) Since this reference covers a wide range of actuators, the user might have to adapt certain attachment kits for some actuators slightly
 Da sich diese Referenz auf eine größere Anzahl von Antrieben bezieht, könnten geringfügige Änderungen bei Anbausätzen einiger Antriebe erforderlich sein
 Comme cette référence couvre une très large gamme de servomoteurs, il se peut que le client pour quelques servomoteurs soit obligé d'adapter légèrement notre kit de montage

**Standard- und Sonder- Anbausätze, sortiert nach Hersteller / Typ des Antriebes
Standard and specific attachment kits classify by manufacturer / type of actuator
Kits de montage standard et spécifique par constructeurs / type de servomoteur**

Type / Version	Model Code of attachment kit	SRD991 SRI990	SRD960	SRP981	SR1983	SR1986	SGE985	SMI983	SMP981
P + W (FLOWSERVE)									
Plugvalve type BR33 in association with adaptation from P+W	Schwenkantrieb / rotary actuator / servomoteur rotatif VDI/VDE 3845 => page 6								
REMOTE Control									
Schwenkantrieb / rotary actuator / servomoteur rotatif VDI/VDE 3845 => page 6									
RESEARCH Control Valves (BADGER METER)									
Series 9000	EBZG-H1	•	•						
Series 754 and 755 size 1/2"	EBZG-B1	•	•						
SAMSON									
Type 271, 3271 (not valid for type 3271-5)	EBZG-H1	•	•						
	EBZG-GN			•	•		•	•	•
	EBZG-HN					•			
Mounting according the VDI/VDE3847 norm	EBZG-N1	•							
Typ 3277 (direct-mount. 1/4NPT) (not valid for type 3277-5)	EBZG-S1	•	Attachment kit without manometre						
	EBZG-S5	•	Attachment kit with manometre						
Typ 3277 (direct-mounting G1/4) (not valid for type 3277-5)	EBZG-S2	•	Attachment kit without manometre						
	EBZG-S6	•	Attachment kit with manometre						
Typ 3277-5 (direct-mounting) Old type with commutation plate fixed with 2 screws	EBZG-S8	•	Not for SRI990, not for SRD960						
Typ 3277-5 (direct-mounting) New type with commutation plate fixed with 1 screw	EBZG-S13	•	Not for SRI990, not for SRD960						
SCHMIDT Armaturen (FLOWSERVE) - FOXBORO Control Valves - ECKARDT									
Direct mounting	EBZG-D	•							
FoxTop / FoxPak (Flowserve)	EBZG-E	•							
SCHLUMBERGER									
Linear Actuator all size :									
Front Mounting	EBZG-S15	•	•						
Side Mounting	EBZG-S16	•	•						
SCHUBERT & SALZER									
	EBZG-FN			•	•		•	•	•
	EBZG-KN					•			
	EBZG-K1	•	•						
SEREG (FLOWSERVE)									
Maxflo "old type"	EBZG-S7	•	•	<- Maxflo first generation produced till 1983					
Maxflo Actuator NR, CNR "new"	EBZG-S4	•	•	<- Only if actuator is prepared for mounting of positioner!					
Maxflo Actuator NR1	EBZG-S4 + BHX426232132	•	•						
Maxflo Actuator NR1	EBZG-SB + BHX426232132			•	•	•	•	•	•
Maxflo Actuator NR2	EBZG-S4 + BHX426232141	•	•						
Maxflo Actuator NR2	EBZG-SB + BHX426232141			•	•	•	•	•	•
Maxflo Actuator NR3	EBZG-S4 + BHX426232152	•	•						
Maxflo Actuator NR3	EBZG-SB + BHX426232152			•	•	•	•	•	•
Maxflo Actuator NR3/NR2/NR1	EBZG-SB			•	•	•	•	•	•
		Only if actuator is prepared for mounting of positioner!							
Maxflo Actuator NX1	EBZG-S9	•	•						
Maxflo Actuator NX2	EBZG-S10	•	•						
Maxflo Actuator NX3	EBZG-S11	•	•						
Sereg Flowserve NL4	EBZG-S14	•	•						

Standard- und Sonder- Anbausätze, sortiert nach Hersteller / Typ des Antriebes
Standard and specific attachment kits classify by manufacturer / type of actuator
Kits de montage standard et spécifique par constructeurs / type de servomoteur

Type / Version	Model Code of attachment kit	SRD991 SR1990	SRD980	SRP981	SR1983	SR1986	SGE985	SM1983	SMP981
SIEMENS									
V series	EBZG-S3	•	•						
SOMAS									
Rotary Actuator Type A	Schwenkantrieb / rotary actuator / servomoteur rotatif VDI/VDE 3845 => page 6								
STAR LINE									
All Rotary actuators	Schwenkantrieb / rotary actuator / servomoteur rotatif VDI/VDE 3845 => page 6								
TURFLIN (XOMOX)									
Model MX60	EBZG-T1	•	•						
Model MX200	EBZG-T2	•	•						
Model MX450, MX750, MX1250	EBZG-T3	•	•						
Model MX3000	EBZG-T4	•	•						
UHDE (SHANZI Project)									
Specifical Application	EBZG-U1	•	•						
VALTEK (FLOWERVE)									
(1) Linear actuators all size with stroke < and = 4 inch	EBZG-V1	•	•						
(1) Linear actuators size 200 and 300 with stroke 6 and 8 inch	EBZG-V4	•	•						
(1) Linear actuators size 200 with stroke 12 inch	EBZG-V5	•	•						
VELAN									
	EBZG-XN			•		•			
VETEC									
Actuator R Series all sizes	EBZG-V2	•	•						
VH-Armaturen									
	Schwenkantrieb / rotary actuator / servomoteur rotatif VDI/VDE 3845 => page 6								
WEHLAN									
	Schwenkantrieb / rotary actuator / servomoteur rotatif VDI/VDE 3845 => page 6								
WORCESTER									
Series 39	EBZG-W1	•							
WYECO - TRACO Control Valves									
Diaphragm actuator type D	EBZG-GN			•	•		•	•	•
	EBZG-HN					•			
	EBZG-H1	•	•						
XOMOX mit EL-O-MATIC									
	Schwenkantrieb / rotary actuator / servomoteur rotatif VDI/VDE 3845 => page 6								

- (1) Since this reference covers a wide range of actuators, the user might have to adapt certain attachment kits for some actuators slightly
 Da sich diese Referenz auf eine größere Anzahl von Antrieben bezieht, könnten geringfügige Änderungen bei Anbausätzen einiger Antriebe erforderlich sein
 Comme cette référence couvre une très large gamme de servomoteurs, il se peut que le client pour quelques servomoteurs soit obligé d'adapter légèrement notre kit de montage

Auswahlhilfe für Anbaukonsolen einiger Hersteller
Help to select the mounting bracket for some manufacturer
Aide au choix de console de montage pour certains constructeurs

AIR TORQUE

Antriebsgröße actuator size taille de servomoteur	Ritzelüberstand / Height of nob B	Bohrbild / Fixings Ax...	Anbaukonsolen / brackets / consoles de montage			
			EBZG-C1 A=80, B=20	EBZG-C2 A=80, B=30	EBZG-C3 A=130, B=50	EBZG-C4 A=130, B=30
DR/SC 15, 30, 60, 100, 150	20	80x30	●			
DR/SC 220, 300, 450, 600	30	80x30		●		
DR/SC 900, 1200, 2000, 3000	50	130x30			●	

AMG

Antriebsgröße actuator size taille de servomoteur	Ritzelüberstand / Height of nob B	Bohrbild / Fixings Ax...	Anbaukonsolen / brackets / consoles de montage			
			EBZG-C1 A=80, B=20	EBZG-C2 A=80, B=30	EBZG-C3 A=130, B=50	EBZG-C4 A=130, B=30
005	11	50x20				
010, 020, 025, 030, 033, 035, 040, 042	20	80x30	●			
045, 050	30	130x30				●

Bar

Antriebsgröße actuator size taille de servomoteur	Ritzelüberstand / Height of nob B	Bohrbild / Fixings Ax...	Anbaukonsolen / brackets / consoles de montage			
			EBZG-C1 A=80, B=20	EBZG-C2 A=80, B=30	EBZG-C3 A=130, B=50	EBZG-C4 A=130, B=30
GTD/GTE-046, -056, -066, -076, - 086, -096, -110, -115, -127	30	80x30		●		
GTD/GTE-143, -163, -185, -210, - 250, -254, -300	30	130x30				●

EL-O-MATIC

Antriebsgröße actuator size taille de servomoteur	Ritzelüberstand / Height of nob B	Bohrbild / Fixings Ax...	Anbaukonsolen / brackets / consoles de montage			
			EBZG-C1 A=80, B=20	EBZG-C2 A=80, B=30	EBZG-C3 A=130, B=50	EBZG-C4 A=130, B=30
ED/ES 12	20	40x31				
ED/ES 25, 40, 65, 100, 200, 350	20	80x30	●			
ED/ES 600, 950, 1600, 2500, 4000	30	130x30				●

Auswahlhilfe für Anbaukonsolen einiger Hersteller
Help to select the mounting bracket for some manufacturer
Aide au choix de console de montage pour certains constructeurs

NORBRO

Antriebsgröße actuator size taille de servomoteur	Ritzelüberstand / Height of nob B	Bohrbild / Fixings Ax...	Anbaukonsolen / brackets / consoles de montage			
			EBZG-C1 A=80, B=20	EBZG-C2 A=80, B=30	EBZG-C3 A=130, B=50	EBZG-C4 A=130, B=30
05 AR/BR 40	13	Dm. 36				
10, 15, 20 AR/BR 40	20	80x30	●			
25, 30, 33, 35 AR/BR 40	30	80x30		●		
40, 42, 45, 50 AR/BR 40	50	130x30			●	

Keystone (Tyco)

Antriebsgröße actuator size taille de servomoteur	Ritzelüberstand / Height of nob B	Bohrbild / Fixings Ax...	Anbaukonsolen / brackets / consoles de montage			
			EBZG-C1 A=80, B=20	EBZG-C2 A=80, B=30	EBZG-C3 A=130, B=50	EBZG-C4 A=130, B=30
79D Models 002, 003, 006, 036	20	80x30	●			
79U/E Models 002, 003, 036	20	80x30	●			
79U/E/D Models 065, 090, 180	30	130x30				●
Models 002 to 036	20		●			
Models 065, 180	30					●

NECESSARY MEASUREMENTS FOR THE DETERMINATION OF ATTACHMENT KIT FOR LINEAR ACTUATORS

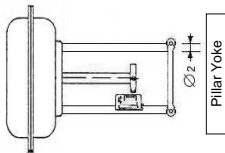
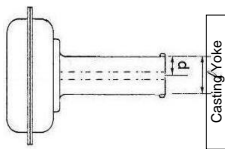
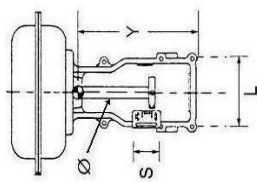

Mesures nécessaires au développement d'un nouveau kit de montage
Necessary measurements to develop a new attachment kit
Notwendige Messungen um ein neues Anbausatz zu entwickeln

Tag N°	Supplier	Model	S	L	Y	Ø	f	P	Ø 2	CARRIER BOLT	EXISTING HOLES		
											FRONT VIEW	LEFT	RIGHT
PV803	Masoneilan	?	30	120	150	30	80	40	/	 Threads 5/16"			

(dimensions in mm)